

SONY



XDCAM

FX9

PXW-FX9/PXW-FX9K

Body Only

Body + SELP28135G

Sony's full-frame 6K sensor camera with Fast Hybrid AF, Dual Base ISO and S-Cinetone™ colour science.

4K

Exmor R
CMOS Sensor

XAVC

MPEG HD422

WiFi
CERTIFIED

α Mount System

OVERVIEW

Full-frame creativity

Realise beautiful 4K imagery with the creative freedom made possible by oversampling a huge high resolution full-frame sensor. Capture every detail from the scene with shallow depth of field and stunning bokeh with a truly cinematic look. 15+ stops of dynamic range and Dual Base ISO enable capture of every nuance, from subtle shadow detail to specular highlights and with an immaculate colour palette.



Capturing the impossible

Make sure your story's always clear with enhanced Fast Hybrid AF that tracks your subject with unprecedented speed, smoothness and precision. Its impact is transformative for premium documentary, commercials and event applications.



Shoot in comfort, expand your horizons

FX9 revolutionises full-frame cinematography with peerless ergonomics and advanced technology for on-the-go shooting. The world's first full-frame electronic variable ND filter* transforms possibilities for shooting in variable lighting conditions. Built-in Wi-Fi and 12G-SDI support advanced workflows while the optional XDCA-FX9 extension unit further expands the operational possibilities of the PXW-FX9.



*As of September 2019

FEATURES

6K Full-Frame "Exmor R" sensor for stunning picture quality

The camera's full-frame 6K sensor provides superb recording in DCI 4K*†, Ultra HD and HD resolutions. Powerful image processing with debayering and oversampling ensures image quality beyond the limits of conventional Super 35mm sensors. The back-illuminated CMOS image sensor also uses Sony's Exmor R technology for improved sensitivity and noise reduction. Compared to a 4K Super 35mm sensor, the FX9's 6K sensor has over twice the surface area while providing a wider angle of view and shallower depth of field.



Super35 17:9 mode with PXW-F57M2.



Full-frame 17:9 mode with PXW-FX9

*4096 x 2160 at 17:9 recoding

Phenomenal 15+ stops dynamic range for limitless expression

FX9 offers an exceptional 15+ stops of dynamic range - beyond the normal range of human perception - allowing for unprecedented creative freedom in colour grading and post. Camera operators can concentrate on framing the scene they want while relying upon the FX9 to capture every nuance and detail using either 4K 4:2:2 10-bit internal recording or 16-bit RAW external recording†. In grading, colourists can find colour and detail beyond the normal viewing abilities of the camera operator to create a final image that exactly portrays the mood of the scene.



Dual Base ISO for stunning images in any light

FX9 features a base sensitivity of ISO 800, providing the optimal dynamic range for typical documentary applications such as shooting outside or in brightly lit interiors. A secondary high base sensitivity of ISO 4000 excels in low light conditions such as early morning and evening shoots while maintaining superb image quality. ISO 4000 is also ideal whenever you're using slow lenses. Combining Dual Base ISO* with the camera's electronic variable ND Filter provides superb creative control in almost any shooting environment, with truly next generation responsiveness to changing conditions.

ISO 800

Ideal for brightly lit scene.



ISO 4000

Ideal for low-light scene.

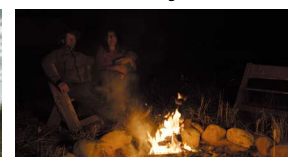

*ISO 800 and ISO 4000 are used in S-Log3, Cine EI mode.

Cinematic colour science with S-Cinetone™

S-Cinetone is the default look of FX9 that's tuned to meet the requirements of today's content creators with rich mid-range colours, alluring facial tones and a softer tonal look – developed with the same expertise as Sony's world-leading VENICE digital cinematography camera. S-Cinetone means that straight out of the camera your content looks fresh and vivid, with subjects that really stand out while retaining plenty of latitude in post production thanks to the high performance full-frame image sensor.

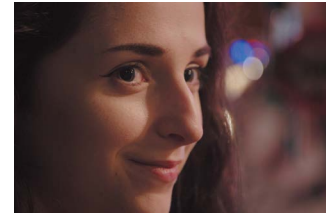

Selectable frame rates in both full-frame & Super 35

Choose your desired frame-rate from 1fps up to 180fps*† for impressive quick and slow-motion footage. FX9 creates an immersive image with a wide angle look and shallower depth of field provided by its full-frame sensor in combination with quick and slow-motion. Engage your audience with this new creative look. FX9 also offers a Quality priority setting** that maximises full HD slow motion image quality with advanced oversampling technology.

* Up to 120fps with Ver1.0

** In Full-frame scanning mode: selectable at 1-30fps / In S35 scanning mode: selectable at 1-60fps

Imager Scan Mode	Recording resolution	Frame Rate			
		1-30p	31-60p	100,120p	150,180p
Full-frame	DCI 4K 4096x2160	✓†	✓†**	-	-
	QFHD 3840x2160	✓	✓†**	-	-
	Full HD 1920x1080	✓	✓	✓	✓†
Super 35	40DCI 4K 4096x2160	✓†	✓†	-	-
	QFHD 3840x2160	✓	✓	✓†*	-
	Full HD 1920x1080	✓	✓	✓	-

* RAW output only

** Angle of view is cropped around 83% of full-frame

Catch the action with enhanced Fast Hybrid AF

Effortlessly track fast moving subjects with pin-sharp focus, even when using wide lens aperture settings to maintain a shallow depth of field with the camera's full-frame sensor. Developed by Sony's α camera engineers, enhanced Fast Hybrid AF combines phase detection AF for fast, accurate subject tracking with contrast AF for exceptional focus accuracy. In addition, Face Detection intelligently recognises and locks on to human faces.

The dedicated 561-point phase detection AF sensor covers approximately 94% of the whole image area width and 96% of height, allowing consistently accurate, responsive AF tracking, even with fast-moving subjects.



96%

94%

Customisable AF settings

FX9's comprehensive autofocus settings provide the creative flexibility to integrate with any project. 7-level AF transition speeds from Fast - switching between subjects as quickly as possible - to Slow, where speed is reduced to fit a more measured shooting style, such as a historical TV drama.

5-level AF subject shift sensitivity ranges from Locked-on - ignoring other moving subjects in the frame - to Responsive that switches focus from one subject to another - ideal for snapping between race cars as they speed by.

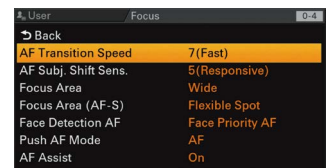

Autofocus with all E-mount lenses

Experience smooth, responsive autofocus with every E-mount lens, including Sony's new Cinema Lens Series with premium optical performance and operability for demanding cinematography applications. Advanced E-mount lever lock operation allows quick, easy lens exchange in the field, plus added stability and security with large lenses.



E-mount lenses line-up as of Sep.2019



E-mount lever lock

▶ World's first electronic variable ND filter for full-frame sensor

Realise even greater creative control with Sony's unique built-in electronic variable neutral density (ND) filter – a world first* for professional full-frame camcorders. Set to Auto, or adjust filter density manually in smooth increments from 1/4 to 1/128 as you shoot, for perfectly exposed images without affecting depth of field as lighting conditions change. Use higher density settings with a slower shutter speed for breathtaking artistic effects.

*As of September 2019



▶ Proven ergonomics & accessory compatibility

FX9 chassis is the latest refinement of the revolutionary FS7 design, so you can be sure it will feel great to shoot with from almost any position, while also offering compatibility with a large proportion of the countless FS7 accessories* including U-series batteries, chargers, E-mount lenses, plus arms and lens adapters.*

The control arm is easily adjusted without tools, so FX9 adapts effortlessly to your physique and preferred shooting style – handheld, at waist level or shoulder mounted.

The smart grip features an updated design, more compact than before while still holding all the key shooting controls, allowing you to concentrate on the scene without distractions. FX9 also introduces a micro USB interface for improved responsiveness and support for a wrist strap.

* BP-U30 and XDCA-FS7 are not compatible with the FX9.



▶ 16-bit RAW capability†

16-bit RAW offers a phenomenal increase in post-production creative freedom to fully exploit FX9's exceptional 15+ stops of dynamic range. FX9 supports export of 16-bit RAW at either 4K or 2K resolution using the optional XDCA-FX9 extension unit with a single BNC cable connection to compatible external RAW recorders.

† Limited to 10-bit recording during 120fps high frame rate shooting within Super35 image circle.

**Compatible recorders to be announced



▶ Stable, shake-free handheld footage

Advanced image stabilisation information means even handheld footage can be transformed with Sony Catalyst Browse/Catalyst Prepare software* in post-production to look as smooth as if it were shot with a gimbal. Unlike in-camera or lens stabilisation, meta data generated by FX9's built-in gyro allows you to creatively choose the balance between the level of shake-compensation and the resolution of trimmed 4K imagery. This feature is also compatible with any E-mount lens and allows for far faster processing than conventional NLE stabilisation workflows**.

* Catalyst Browse/Catalyst Prepare Ver.2019.2 is required.

** Resolution and angle of view reduced compared to native footage.

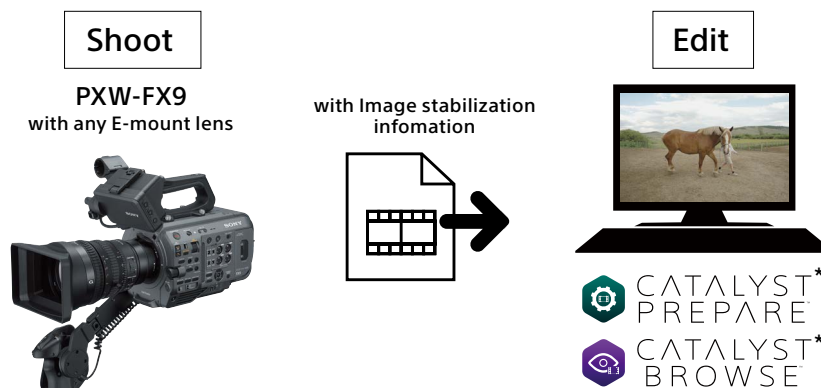

Beautifully matched shooting partners

Optimised for professional cinematography applications, the light, compact, SELP28135G powered zoom lens is an ideal complement for the full frame imaging possibilities of the FX9.

- Circular aperture with full-frame image circle format
- Motorised servo zoom for smooth, precise zoom moves
- Independent three rings for focus, zoom and iris with smooth, silent drive

You have the choice of purchasing the FX9 on its own (PXW-FX9) or with SELP28135G lens (PXW-FX9K).



Adds shoulder-style operation, advanced networking

Further extend the capabilities of the FX9 with the optional XDCA-FX9 extension unit that optimises camera weight distribution and ergonomics for comfortable shoulder-style shooting – ideal for ENG (Electronic News Gathering) and documentary applications. The extension unit also adds advanced networking for streaming/file transfers and Timecode for multi-camera shoots.



4-channel audio input and recording

FX9 offers superb audio capabilities with independent control dials for each channel. In applications such as interview, 4-channel audio recording enables simultaneous use of an external microphone for recording ambient sounds, the built-in microphone for voice memos by the operator, and two optional UWP Series wireless microphones for voice of interviewer and interviewee. In addition, using the optional XLR-K3M, XLR-K2M or XLR-K1M XLR adapter – with two extra XLR inputs – allows even more devices to be connected.



Multi-Interface (MI) Shoe

Sony's flexible Multi-Interface (MI) Shoe provides power, signal connections and coordinated on/off switching with compatible Sony accessories. For example, you can connect and control Sony UWP-D wireless microphone systems (optional).



Networked for high mobility

The FX9 features internal 5GHz* and 2.4GHz Wi-Fi capability as standard. Just switch on and log onto your preferred network to enable a host of advanced wireless production features:

- Content Browser Mobile™** allows the PXW-FX9 to be controlled remotely from a smartphone or tablet computer via a Wi-Fi connection. Adjust the exposure level, zoom, Record/Stop and more via your mobile device - it's ideal for single operator shoots. One-touch authentication is also possible with smartphones offering NFC connectivity.
- FTP Transfer allows content files to be sent over the internet for remote storage on an FTP server even while shooting. In case of signal interruption, the system will automatically resume as soon as connection restored.
- Trimming allows you to set start and end points in a clip, eliminating time-wasting transfers of unneeded content.
- XDCAM air can upload proxy footage to the cloud from multiple camera operators in the field, so editing can start immediately. Uploaded content can be accessed securely from any location. News teams can even start logging clips while shooting is still going on, saving even more valuable time when a story's breaking.
- Wired LAN port with optional XDCA-FX9 allows connection of the FX9 to the Internet with a standard Ethernet cable, allowing files to be streamed or transferred by FTP.
- Dual Link Cellular is enabled with optional XDCA-FX9 and uses two cellular networks in combination to provide an even more reliable network connection. FX9 is compatible with standard USB cellular dongles from most networks. (Please check for most appropriate service provider for your region. Standard network fees will apply.)
- High quality Sony QoS Streaming to Network RX station (optional) and XDCAM air by Sony allows images to be streamed live for viewing at a remote location.

*5GHz support dependent on country/regional regulation. ** Content Browser Mobile™ application can be downloaded from Google Play Store or App Store. Wi-Fi operation cannot be guaranteed with all smartphones and tablet computers.

† Future update

Related Accessories

XDCA-FX9

Extension Unit for FX9 camera

▶ Enhanced operability with advanced networking, wireless audio† and RAW output†

Connecting directly to the PXW-FX9 camera with no cables needed, the XDCA-FX9 extension unit provides convenient additional features to enhance shooting convenience and flexibility. The XDCA-FX9 allows easy fitting of BP-GL and BP-FL series batteries, extending camera operating times during the most demanding shoots. Attaching quickly and easily to the rear of the PXW-FX9 via a multi pin connector, the XDCA-FX9 provides advanced networking capabilities for streaming or file transfer via Ethernet or dual link cellular connection. It also allows the easy addition of high quality wireless audio† via a wireless receiver slot. Additional output connectors including timecode, and D-tap are also provided. 16-bit RAW signals can be recorded via XDCA-FX9 RAW output† via XDA-FX9 RAW output by using a third-party external recorder.



FE C 16-35mm T3.1 G

SELC1635G

FE C 16-35mm T3.1 G Cinema Lens Series full-frame wide angle zoom with advanced optical performance, operability and intelligent shooting functions



OVERVIEW

▶ Cinematic images with beautiful bokeh

Experience beautiful cinematic images, with excellent corner-to-corner resolution and consistent T3.1 (F2.8) large aperture from wide to telephoto for stunning background bokeh effects.



▶ Responsive manual control for content creators

Adjust focus, zoom and iris with smooth, consistent precision. Enjoy fine control over realising your artistic vision with large-format sensor camera of the FX9.



▶ Shoot with extra intelligence

Enjoy smart functions unique to Sony's E-mount lens system, including AF (autofocus) support, servo zoom and zoom/iris/focus control from your camera, remote or smartphone, allowing cinematographers to concentrate on composition and focus without touching lens rings.*

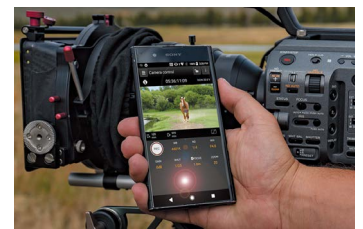

* Requires compatible cameras, remote controllers, smartphones and mobile apps.

FEATURES

▶ Unlimited expression for content creators

Explore new artistic possibilities and precise creative control with Cinema Lens Series – the refined expression of Sony’s technological expertise for uncompromising content creators. This wide angle zoom lens is optimised for digital cinematography, documentary production and other premium content produced with full-frame camera of the FX9.



▶ Advanced optical design

Two XA (Extreme Aspherical) lens elements and three aspheric elements minimise distortion, curvature and astigmatism. Two ED (Extra-low Dispersion) glass elements suppress colour distortion, while an advanced nano AR (Anti Reflection) coating on optical surfaces drastically reduces flare and ghosting. The floating focus mechanism is optimised for motion picture applications, ensuring outstanding resolution and very low distortion at any shooting distance.



XA (Extreme Aspherical) lens

▶ Smooth, natural bokeh

An ideal partner for the full-frame sensor of Sony’s acclaimed FX9 camera, the consistent T3.1 (F2.8) large aperture and circular 11-blade aperture of the SELC1635G lets professional cinematographers enjoy shallow depth of field and the creation of beautifully smooth bokeh (background defocus) effects.

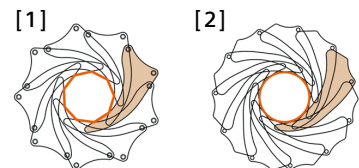

[1] Conventional aperture
[2] Circular aperture

▶ Precise, responsive manual focus

Linear Response MF enables smooth, lag-free manual focus, allowing DoPs and camera operators to adjust focus accurately and intuitively. The focus ring offers a 120deg large angle of rotation for finer control, with distance scale markers for consistent focus reset during multiple takes. For complete creative control to suit any user including photographers who are used to shooting stills, SELC1635G also offers reversible zoom ring rotation, modes switchable between AF/MF and Full manual, and the option to engage 'click stops', providing tactile feedback for precise adjustments of the aperture ring. When the click stops are disengaged, the aperture ring moves smoothly and quietly.



[1] Focus ring
[2] Zoom ring
[3] Iris ring

▶ More options for content creators

The SELC1635G has a 0.8mm pitch gear and 114mm lens diameter, which is regarded as the industry standard in cinematography, providing compatibility with a wide range of accessories include matte boxes and follow focus systems.



▶ Detachable servo zoom

The included servo unit provides comfortable fingertip control for smooth, gradual zooms suitable for a slow moving drama or promotional video. Servo and Manual control are switchable by the button on the lens unit, and while set to servo, you can control zoom via camera’s handle or grip zoom.

Also, the servo can be detached if preferred, making the lens lighter and more portable.



▶ Fast, accurate AF and AE

The SELC1635G fully supports the enhanced Hybrid phase/contrast detection autofocus (AF) and Auto Exposure (AE) capabilities of the FX9 full-frame camera. This breakthrough technology allows you to concentrate on framing while the camera and lens work seamlessly together to maintain focus on subjects with shallow depth of field.

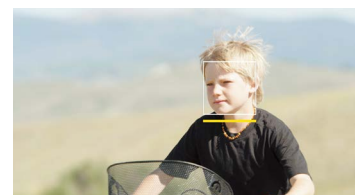

SPECIFICATIONS

General	Mass	Approx 2.0 kg (body only) Approx. 4.8 kg (with Viewfinder, Eyepiece, Grip Remote Control, BP-U35 battery, SELP28135G LENS, an XQD memory card, Handle, MIC holder)		
	Dimensions (W x H x D) [F. W100011]	146 x 142.5 x 229 mm (body without protrusions)		
	Power Requirements	DC 19.5V		
	Power Consumption	Approx. 35.2 W (while recording XAVC-I QFHD 59.94p, SELP28135G Lens, Viewfinder ON, not using external device)		
	Operating Temperature	0°C to 40°C 32°F to 104°F		
	Storage Temperature	-20°C to +60°C -4°F to +140°F		
	Battery Operating Time	Approx. 54min. with BP-U35 battery (while recording XAVC-I QFHD 59.94p, SELP28135G Lens, Viewfinder ON, not using external device) Approx. 108min. with BP-U70 battery (while recording XAVC-I QFHD 59.94p, SELP28135G Lens, Viewfinder ON, not using external device)		
	Recording Format (Video)	[XAVC Intra]	XAVC-I QFHD 59.94p mode: VBR, MAX bit rate 600 Mbps, MPEG-4 AVC/H.264 XAVC-I QFHD 50p mode: VBR, MAX bit rate 500 Mbps, MPEG-4 AVC/H.264 XAVC-I QFHD 29.97p mode: VBR, MAX bit rate 300 Mbps, MPEG-4 AVC/H.264 XAVC-I QFHD 25p mode: VBR, MAX bit rate 250 Mbps, MPEG-4 AVC/H.264 XAVC-I QFHD 23.98p mode: VBR, MAX bit rate 240 Mbps, MPEG-4 AVC/H.264 XAVC-I HD 59.94p mode: CBG, MAX bit rate 222 Mbps, MPEG-4 AVC/H.264 XAVC-I HD 50p mode: CBG, MAX bit rate 223 Mbps, MPEG-4 AVC/H.264 XAVC-I HD 59.94/29.97p mode: CBG, MAX bit rate 111 Mbps, MPEG-4 AVC/H.264 XAVC-I HD 50i/25p mode: CBG, MAX bit rate 112 Mbps, MPEG-4 AVC/H.264 XAVC-I HD 23.98p mode: CBG, MAX bit rate 89 Mbps, MPEG-4 AVC/H.264	
		[XAVC Long]	XAVC-L QFHD 29.97p/25p/23.98p mode: VBR, MAX bit rate 100 Mbps, MPEG-4 H.264/AVC XAVC-L QFHD 59.94p/50p mode: VBR, MAX bit rate 150 Mbps, MPEG-4 H.264/AVC XAVC-L HD 59.94i/29.97p/50i/25p/23.98p/59.94p/50p mode: VBR, MAX bit rate 50 Mbps, MPEG-4 H.264/AVC XAVC-L HD 59.94i/29.97p/50i/25p/23.98p/59.94p/50p mode: VBR, MAX bit rate 35 Mbps, MPEG-4 H.264/AVC XAVC-L HD 59.94i/50i mode: VBR, MAX bit rate 25 Mbps, MPEG-4 H.264/AVC	
		[MPEG-2 Long GOP]	MPEG2 HD422 mode: CBG, MAX bit rate 50 Mbps, MPEG-2 422P@HL LPCM 24 bits, 48 kHz, 4 channels	
		Recording Format (Audio)	[XAVC Intra]	
		Recording Frame Rate	[XAVC Intra]	XAVC-I QFHD mode: 3840 x 2160/59.94p, 50p, 29.97p, 23.98p, 25p XAVC-I HD mode: 1920 x 1080/59.94p, 50p, 50i, 29.97p, 23.98p, 25p
			[XAVC Long]	XAVC-L QFHD mode: 3840 x 2160/59.94p, 50p, 29.97p, 23.98p, 25p XAVC-L HD 50 mode: 1920 x 1080, 1280x720/59.94p, 50p, 59.94i, 50i, 29.97p, 23.98p, 25p XAVC-L HD 35 mode: 1920 x 1080/59.94p, 50p, 59.94i, 50i, 29.97p, 23.98p, 25p XAVC-L HD 25 mode: 1920 x 1080/59.94i, 50i
			[MPEG-2 Long GOP]	MPEG HD422 mode: 1920 x 1080/59.94i, 50i, 29.97p, 23.98p, 25p
			[XAVC Intra]	XAVC-I QFHD 59.94p When using QD-G128A (128 GB): Approx. 22 minutes When using QD-G64A (64 GB): Approx. 10 minutes XAVC-I QFHD 50p When using QD-G128A (128 GB): Approx. 26 minutes When using QD-G64A (64 GB): Approx. 13 minutes XAVC-I QFHD 29.97p When using QD-G128A (128 GB): Approx. 43 minutes When using QD-G64A (64 GB): Approx. 21 minutes XAVC-I QFHD 25p When using QD-G128A (128 GB): Approx. 52 minutes When using QD-G64A (64 GB): Approx. 25 minutes XAVC-I QFHD 23.98p When using QD-G128A (128 GB): Approx. 54 minutes When using QD-G64A (64 GB): Approx. 26 minutes XAVC-I HD 59.94p When using QD-G128A (128 GB): Approx. 57 minutes When using QD-G64A (64 GB): Approx. 28 minutes XAVC-I HD 50p When using QD-G128A (128 GB): Approx. 57 minutes When using QD-G64A (64 GB): Approx. 27 minutes XAVC-I HD 59.94i/29.97p When using QD-G128A (128 GB): Approx. 105 minutes When using QD-G64A (64 GB): Approx. 53 minutes XAVC-I HD 50i/25p When using QD-G128A (128 GB): Approx. 105 minutes When using QD-G64A (64 GB): Approx. 53 minutes XAVC-I HD 23.98p When using QD-G128A (128 GB): Approx. 130 minutes When using QD-G64A (64 GB): Approx. 65 minutes
			[XAVC Long]	XAVC-L QFHD 29.97p/25p/23.98p When using QD-G128A (128 GB): Approx. 125 minutes When using QD-G64A (64 GB): Approx. 62 minutes XAVC-L QFHD 59.94p/50p When using QD-G128A (128 GB): Approx. 86 minutes When using QD-G64A (64 GB): Approx. 42 minutes XAVC-L HD 59.94i/29.97p/50i/25p/23.98p/59.94p/50p When using QD-G128A (128 GB): Approx. 225 minutes When using QD-G64A (64 GB): Approx. 110 minutes XAVC-L HD 35 59.94i/29.97p/50i/25p/23.98p/59.94p/50p When using QD-G128A (128 GB): Approx. 305 minutes When using QD-G64A (64 GB): Approx. 150 minutes XAVC-L HD 25 59.94i/50i When using QD-G128A (128 GB): Approx. 410 minutes When using QD-G64A (64 GB): Approx. 200 minutes

General	Recording/Playback Time	[MPEG-2 Long GOP] MPEG HD422 59.94i, 50i, 29.97p, 23.98p, 25p When using QD-G128A (128 GB): Approx. 220 minutes When using QD-G64A (64 GB): Approx. 105 Minutes
	Recording Format (Proxy Audio)	XAVC Proxy: AAC-LC, 128 kbps, 2 channels
	Recording Format (Proxy Video)	XAVC Proxy: AVC/H.264 Main Profile 4.2: 2.0 Long GOP, VBR 1920x1080, 9Mbps 1280x720, 9Mbps 1280x720, 6Mbps 640x360, 3Mbps
Lens	Lens Mount	E-mount
	Imaging Device (Type)	35 mm full-frame, singlechip CMOS image sensor
Camera Section	Imaging Device (Pixel Count)	20.5M pixels (Total)
	Built-in Optical Filters	Clear, linear variable ND(1/4ND to 1/128ND)
	ISO Sensitivity	ISO 800/4000 (Cine EI mode, D55 Light source)
	S/N Ratio	57 dB (Y) (typical)
	Shutter Speed	64k to 1/8000 sec
	Slow and Quick Motion Function	FF 6k mode: XAVC-I/L 3840 x 2160, 1920x1080 1 to 30 frames (29.97/25/23.98)
		S35 4k mode: XAVC-I/L 3840 x 2160, 1920x1080 1 to 60 frames (59.94p, 50p, 29.97/25/23.98)
	White Balance	FF 2k, S35 2k mode: XAVC-I/L 1920x1080 1 to 60, 100, 120 frames (59.94p, 50p, 29.97/25/23.98)
		Gain
	Gamma Curve	S-Cinetone, STD1, STD2, STD3, STD4, STD5, STD6, HG1, HG2, HG3, HG4, HG7, HG8, S-Log3
Latitude	T5+ stop	
Audio Input	XLR-type 3-pin (female) (x2), line/mic/mic +48 V selectable Mic Reference: -30 to -80 dbu	
Input/Output	SDI Output	SDI OUTPUT: BNC, 12G-SDI, 3G-SDI (Level A/B), HD-SDI SDI OUTPUT: BNC, 3G-SDI (Level A/B), HD-SDI
	USB	USB device, micro-B (x1)
	Headphone Output	Stereo mini jack (x1) -16 dbu 16 Ω
	Speaker Output	Monaural
	DC Input	DC Jack
	Remote	Stereo mini-minijack (Ø2.5 mm)
	HDMI Output	Type A (x1)
	Monitoring	LCD 8.8 cm (3.5 type) Approx. 2.76M dots
	Built-in Microphone	Built-in Microphone Omni-directional monoral electret condenser microphone.
	Media	Type XQD Card slot (x2) SD/MS Card slot (x1) for saving configuration data SD card slot also can be used for proxy video recording
Wi-Fi/NFC	Supported Format	IEEE 802.11 a/b/g/n/ac
	Frequency Band	2.4 GHz bandwidth 5.2/5.3/5.6/5.8 GHz bandwidth*
	Security	WEP/WPA-PSK/WPA2-PSK
	NFC	NFC Forum Type 3 Tag compliant Body Cap(1)
Supplied Accessories	Supplied Accessories	Viewfinder (1) Eyepiece (1) Grip Remote Control (1) IST293 power cord (2) ** AC Adapter BC-UTA battery charger (1) BP-U35 battery pack (1) Power cord (2) USB cable (1) Operating Guide (2) CD-ROM "Manuals for Solid-State Memory Camcorder" (1)

* Depending on country/regional regulation
** For India only. Not supplied in other countries

DIMENSIONS

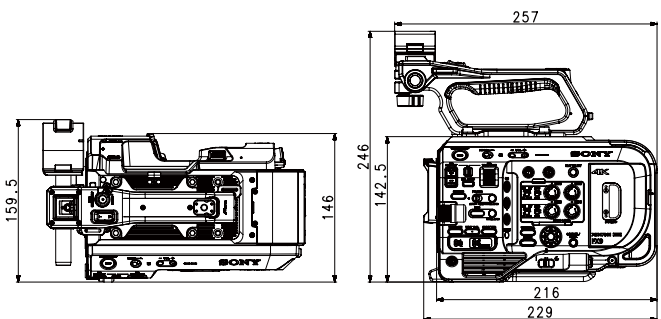

Humberto 1° 2889, C1231ACE- Bs. Aires, Argentina
 Tel: +54 11 4122 1200 / Fax: +54 11 4308 5493
 info@viditec.com.ar viditec.com